

# Exceptional energy efficiency, reliability and performance

Avanta – representing Remeha’s new seventh generation in domestic condensing boiler development – makes use of leading edge technology to create one of the most compact and lightest domestic boilers on the market.



Combination Boiler	24c	28c	28Eco	35c	39c
System Boiler	18s	24s	30s		
Heating Boiler	12v	15v	18v	24v	30v

## Quality, reliability and value

Remeha’s boilers deliver value for money throughout their entire life. The high efficiency Avanta gas condensing combination, system and heating boiler ranges are backed by a sector-leading five-year guarantee, reflecting Remeha’s confidence in its products and offering both installers and end-users exceptional peace of mind.

Indeed, to guarantee the ultimate in reliability, each boiler is supplied fully live tested and pre-set.

Avanta boilers offer a dazzling array of features and benefits. The entire range operates at low water pressure – a minimum of 0.5 bar to achieve maximum flow rate – making it the perfect solution in a wide range of applications including for low-pressure areas and multi-storey flats.



## Special features

- All LPG convertible.
- Boilers come with a wall mounting plate complete with gas/water isolating valves for easy and time saving installation\*.
- A comfort mode (keep hot facility) guarantees instantaneous hot water of constant temperature.
- Automatic bypass.
- Boiler frost protection.
- An eco-mode for energy saving and environmentally friendly operation.
- Low water protection.
- External interlock function.
- Intelligent advanced boiler control for reliable and accurate operation.
- Room sealed operation with no compartment ventilation required.
- Solar compatibility.
- Underfloor heating compatibility.
- Data file storage for easy servicing and fault logging.
- Filling loop.
- Filter in DHW cold feed.
- Maximum three eco-home credits for all projects – Re: NOx emissions.
- Single design concept for the whole range.

## Environmentally sound

The high efficiency Avanta boilers (90.3 per cent efficient) are specifically designed to be as environmentally friendly as possible with ultra low NOx emissions. Each boiler in the range also provides optimum hot water and heating for the home with reduced carbon dioxide emissions, a key contributor to climate change.

\*Excludes the 28Eco model

# Avanta Combination Boiler

Height 670mm Depth 300mm Width 400mm | Weight 30.5kg\*



## Flexible siting

The Avanta Plus Combi boiler is so compact that it will fit into almost any available space in the home, increasing siting flexibility so that the customer has a greater choice when deciding where to place the boiler.

## Maximum comfort

A comfort mode (keep hot facility) ensures the boiler delivers instantaneous hot water at a constant temperature, resulting in better user comfort and greater convenience.

## Green operation

The Avanta Plus Combi boiler's Eco mode saves energy, maximises efficiency and ensures environmentally friendly operation.

## Versatile configuration

With a simple boiler set up, the 35 and 39 Combi boilers can be used as a larger system boiler when required.



Combi Boiler



Combi Eco Boiler

## Nominal Outputs and Flow rates

### 24kW Avanta Combination Boiler

Nominal Output Pn (80/60°C)	6-20.0kW
Nominal Output Pn (50/30°C)	6-21.6kW
DHW Flow Rate @ 35°C Rise	10.0l/min

### 28kW Avanta Combination Boiler

Nominal Output Pn (80/60°C)	6-21.6kW
Nominal Output Pn (50/30°C)	6-23.0kW
DHW Flow Rate @ 35°C Rise	11.4l/min

### 35kW Avanta Combination Boiler

Nominal Output Pn (80/60°C)	6-29.4kW
Nominal Output Pn (50/30°C)	6-31.3kW
DHW Flow Rate @ 35°C Rise	14.2l/min

### 39kW Avanta Combination Boiler

Nominal Output Pn (80/60°C)	6-33.3kW
Nominal Output Pn (50/30°C)	6-35.5kW
DHW Flow Rate @ 35°C Rise	15.9l/min

### 28kW Avanta Eco Boiler

Nominal Output Pn (80/60°C)	6-21.6kW
Nominal Output Pn (50/30°C)	6-23.0kW
DHW Flow Rate @ 35°C Rise	11.4l/min

**remeha**  
creating energy solutions

\*The 24c, 28c and 28Eco are 30.5kg. The 35c is 32kg the 39c is 34.5kg.  
Warranty terms & conditions: Avanta Boiler 5 year parts and 2 years labour warranty, Avanta Eco Boiler 2 years parts and 2 years labour warranty.

# Avanta System Boiler

Height 670mm Depth 300mm Width 400mm | Weight 29kg\*



SEDBUK BAND  
CONDENSING BOILER



## Space saving dimensions

The Avanta Plus system boiler range takes full advantage of cutting edge technology to create one of the most compact boilers available. It is the only system boiler range that will fit inside a standard kitchen unit.

## Reliable operation

Offering impressive outputs ranging from 6kW to 30kW, the boiler can be pressurised and tested fully before installation to prevent teething problems and ensure trouble-free operation.

## Convenient servicing

A user friendly digital display ensures easy commissioning and servicing with self diagnostic codes at user, service engineer and factory access levels. This means the customer can be assured that boiler servicing will be as fast and convenient as possible and involve the minimum of disruption.

## High efficiency

Fully modulating gas/air ratio control, anti-cycling facility and ultra low NOx emissions ensure the boiler is extremely efficient and environmentally friendly in operation.



System Boiler

## Nominal Outputs and Flow rates

### 18kW Avanta System Boiler

Nominal Output Pn (80/60°C)	6-18.0kW
Nominal Output Pn (50/30°C)	6-19.1kW

### 24kW Avanta System Boiler

Nominal Output Pn (80/60°C)	6-21.6kW
Nominal Output Pn (50/30°C)	6-23.0kW

### 30kW Avanta System Boiler

Nominal Output Pn (80/60°C)	6-29.4kW
Nominal Output Pn (50/30°C)	6-31.3kW

\*The 18s and 24s are 29kg the 30s is 32kg.  
Warranty terms & conditions:  
Avanta Boiler 5 year parts and 2 years labour warranty.

# Avanta Heating Boiler

Height 600mm Depth 290mm Width 400mm | Weight 20.0kg\*



SEDBUK BAND  
CONDENSING BOILER



## Space saving dimensions

The Avanta Heating boiler will fit into almost any available space, proving that small is flexible.

The 12v, 15v, 18v, 24v and 30v Heating boilers complete the Avanta Range, enabling the installer to always use a Remeha boiler when specifying a replacement.

Adopting the very latest in domestic boiler technology, the new Remeha Avanta Heating boiler was developed to be one of the most compact boilers available on the market. The output ranges between 6kW to 30kW. The compact dimensions of this boiler and its overall efficiency make it a popular choice.



Heat only Boiler

## Nominal Outputs and Flow rates

### 12kW Avanta Heating Boiler

Nominal Output Pn (80/60°C)	6-12.1kW
Nominal Output Pn (50/30°C)	6-12.8kW

### 15kW Avanta Heating Boiler

Nominal Output Pn (80/60°C)	6-15.0kW
Nominal Output Pn (50/30°C)	6-15.8kW

### 18kW Avanta Heating Boiler

Nominal Output Pn (80/60°C)	6-17.6kW
Nominal Output Pn (50/30°C)	6-19.0kW

### 24kW Avanta Heating Boiler

Nominal Output Pn (80/60°C)	6-23.5kW
Nominal Output Pn (50/30°C)	6-25.0kW

### 30kW Avanta Heating Boiler

Nominal Output Pn (80/60°C)	6-29.4kW
Nominal Output Pn (50/30°C)	6-31.3kW

\*The 24v and 30v are 21.5kg.  
Warranty terms & conditions:  
Avanta Boiler 5 year parts and 2 years labour warranty.

# Quick and easy to install

The Avanta Range is probably one of the most installer friendly boilers on the market. A single design concept throughout the range makes it simple to understand and install and extremely easy to service.



## Quick and easy installation

The Avanta Range is designed for easy and time saving installation. The installation can be pressurised and tested before boiler installation. For ease of installation the Avanta Range comes supplied with a wall mounting plate complete with valves and pre-formed tails. The Avanta Range is supplied with all water and gas isolation valves complete with copper tails.

### Wall mounting plate

The wall mounting plate is supplied as standard complete with gas/water isolating valves and pre-formed copper tails\*.

### Stand off frame (optional – 30mm deep)

A stand off frame is available as an option; this combines with the wall plate to allow the supplied copper tails to be reversed to run up behind the boiler if required.

### Pipework kit (optional – preformed)

To make life even easier for the installer a complete pre-formed pipework kit is available as an option, this combined with the stand off frame brings all the connections to the top of the boiler.

\*Excludes the 28Eco model

## Flexible flue arrangements

Remeha's new low profile flue terminal has two important advantages over conventional terminals – first it is more aesthetically pleasing, an important consideration if the boiler is likely to be installed in a kitchen or elsewhere where it will be exposed and, secondly, it reduces the clearance required above the boiler by around 80mm, from 250mm to 170mm, thus increasing siting flexibility. Making boiler placement even more adaptable, the flue can be placed in one of four positions at 90 degrees – backwards, forwards, left or right.

To complete its comprehensive flue range – which also includes conventional flues, plume management systems and balcony terminal kits – Remeha also offers a telescopic flue that can easily accommodate wall thicknesses of 250mm to 450mm with no cutting involved. This means that, for the majority of installations, the installer simply positions the flue, checks and confirms its length, fixes it in position with a supplied screw, and seals it. This dramatically reduces the time and effort needed to fit the flue.

However, the telescopic flue's versatility does not stop there – if it is to be installed in a thinner wall, the flue can be cut to a minimum length of around 150mm. The telescopic flue system comprises a tough polyphenylene sulphide (PPS) plastic inner flue and a white painted steel outer pipe offering clean lines and durability.

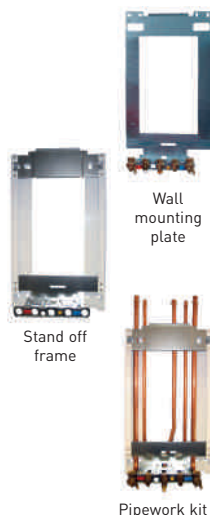

Stand off frame

Wall mounting plate

Pipework kit

# Energy saving solutions for peak performance

When controlled, using outside or room sensors, the Avanta range will fully modulate to maximise efficiency, save energy, reduce emissions and cut fuel bills.

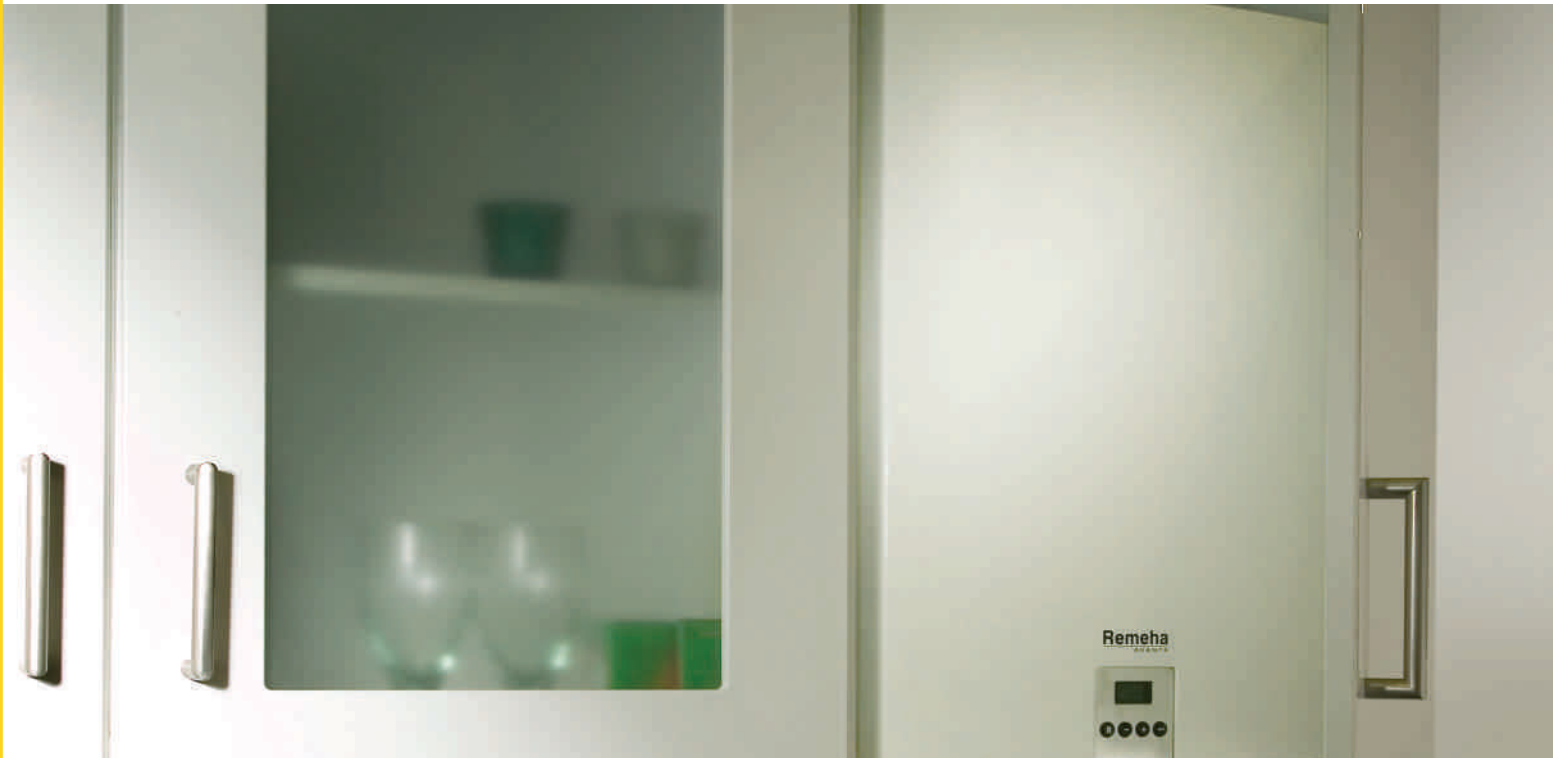

## Looking after the Avanta is simplicity itself

The entire Avanta range uses a single design concept; the range is fitted with a minimum number of standard components, is simple to understand and requires minimal maintenance and servicing. Although the Avanta range is compact, it has been designed so that all parts are easily accessible and exchangeable ensuring ease of service even if mounted in a wall cupboard.

For the installer, Remeha offers Recom® service kit c/w monitoring software making it possible to log, read out or change the boiler operating parameters dynamically by using a notebook computer. An optional hardware connection cable is also available.

Other features of Recom® include:

- Change of boiler settings.
- Boiler monitoring functionality (e.g. fan speed, flow and return temperature).
- Log of lock out and shut down history.
- Boiler fault indication – last 16 faults logged.

## Modulating controls

Flow temperature is directly controlled by an outside weather or inside room compensator to provide the ultimate in comfort at all times using the OpenTherm® communication standard (see page 8).

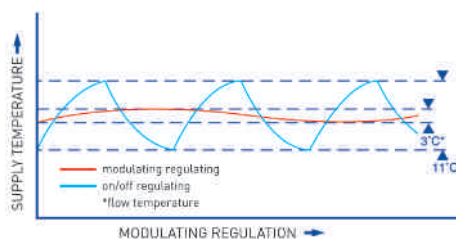

- Direct communication with boiler.
- Self-diagnostic read out.

## Modulation advantages

Modulation offers important financial, comfort and environmental benefits, including:

- Gas saving, less energy consumption due to higher efficiency.
- Additional energy savings because in general the set point of the room thermostat can be set a degree lower without sacrificing comfort.
- Modulation prevents cycling, reducing wear and maintenance costs.
- Fewer emissions of unburned gas due to reduced number of burner starts, environmentally friendly.
- Increased comfort due to lower fluctuations in water and air temperatures.
- Reduced emissions of harmful gases such as NOx and CO<sub>2</sub>.

# Commissioning and service friendly

Remeha offers a host of sophisticated, user-friendly controls to make commissioning, servicing and maintenance easy, and has developed simple-to-use plug and play boiler self-diagnostic software to speed up fault finding and lessen disruption to the householder.



Outside Sensor

## Controls

For freedom of choice, the Avanta range can be controlled with internal or external time clocks, room thermostats or volt-free systems including wireless control solutions. Moreover, Avanta boilers support modulating controls using the OpenTherm® communication standard, a non-manufacturer-dependent system of communication between modulating HVAC heating appliances and room thermostats.

Advantages of OpenTherm® for the customer include:

- Increased comfort.
- Lower costs.
- Wider selection of products.
- Remote control.
- Increased life span.
- Extra functions.
- No batteries required.
- Ready for future expansion.

Remeha's own attractively designed, user-friendly iSense room thermostat with modulating weather control has simple, intuitive controls (two buttons, one turn-and-press dial) that modulate the boiler's output to match a fixed flow set point temperature, saving energy, reducing emissions and maximising efficiency.

Other benefits of iSense include:

- Extremely user-friendly: no complex instruction manual required.
- Clear LCD display, equipped with a backlight when in use (batteries required).
- Extensive setting options with handy and clear (scrolling) help menu.
- Three user levels (basic, standard and advanced).
- Quick choices (direct temperature setting available: timer programme, continuous day, continuous night, frost protection, summer setting, open hearth).

However, the boilers themselves also incorporate more sophisticated controls. The intelligent advanced boiler controller ('abc') is equipped with an electronic control and safety unit. This continuously monitors boiler output and ensures a reliable supply of heat.

The control system can also prevent negative influences such as flow reduction or airflow problems causing lock-out situations. Should such circumstances arise, the boiler will, in the first instance, modulate down. If necessary, it will temporarily switch off and then simply try to switch on without manual intervention and keep running.

Provided the situation is not hazardous, the boiler will always try to supply heat. In this way, the abc control can minimise unnecessary engineer call outs and the resulting expense and hassle. See page 10 for more on controls in general and Remeha's "abc" intelligent controller in particular.

# Remeha customer support services

Remeha's dedicated pre-and-after-sales teams are ready to give both the installer and householder the support they need. It's an integral part of the quality package that Remeha offers as standard with all products.



## Technical Service Training

Remeha offers training across the entire product range. For installation and service/maintenance contractors we hold Technical Training Courses at our fully equipped and modern training centre in Wokingham. Courses are also available at our regional training premises. The Avanta Range is designed on a single design concept, so training on just one product covers the whole range. The technical training consists of theoretical and practical training, installation, commissioning and fault finding.

## Spare Parts Kit

In close co-operation with contractors, Remeha has developed an extensive spare parts/emergency kit which enables authorised service engineers to provide prompt attention in an emergency situation and fix the boiler on first visit. The spare parts kit includes all major parts that may be required for a breakdown. Remeha has a comprehensive training centre which is used to supply half-day technical training.

## Literature available online

Browse and explore the [www.avantarange.com](http://www.avantarange.com) website and you will find all up to date technical literature and relevant information. For easy access you can download all literature and drawings in Adobe Acrobat Reader (.pdf) format. Adobe Acrobat Reader is downloadable free of charge from [www.adobe.co.uk](http://www.adobe.co.uk)

## Email

[boilers@remeha.co.uk](mailto:boilers@remeha.co.uk)

## Website

[www.avantarange.com](http://www.avantarange.com)

For all your queries just call the Avanta Team on: 0118 978 3434



# Horizontal and vertical flue systems

The Avanta Range is designed for room sealed operation and no compartment ventilation is required. It must be installed with the correct Remeha approved flue accessories.

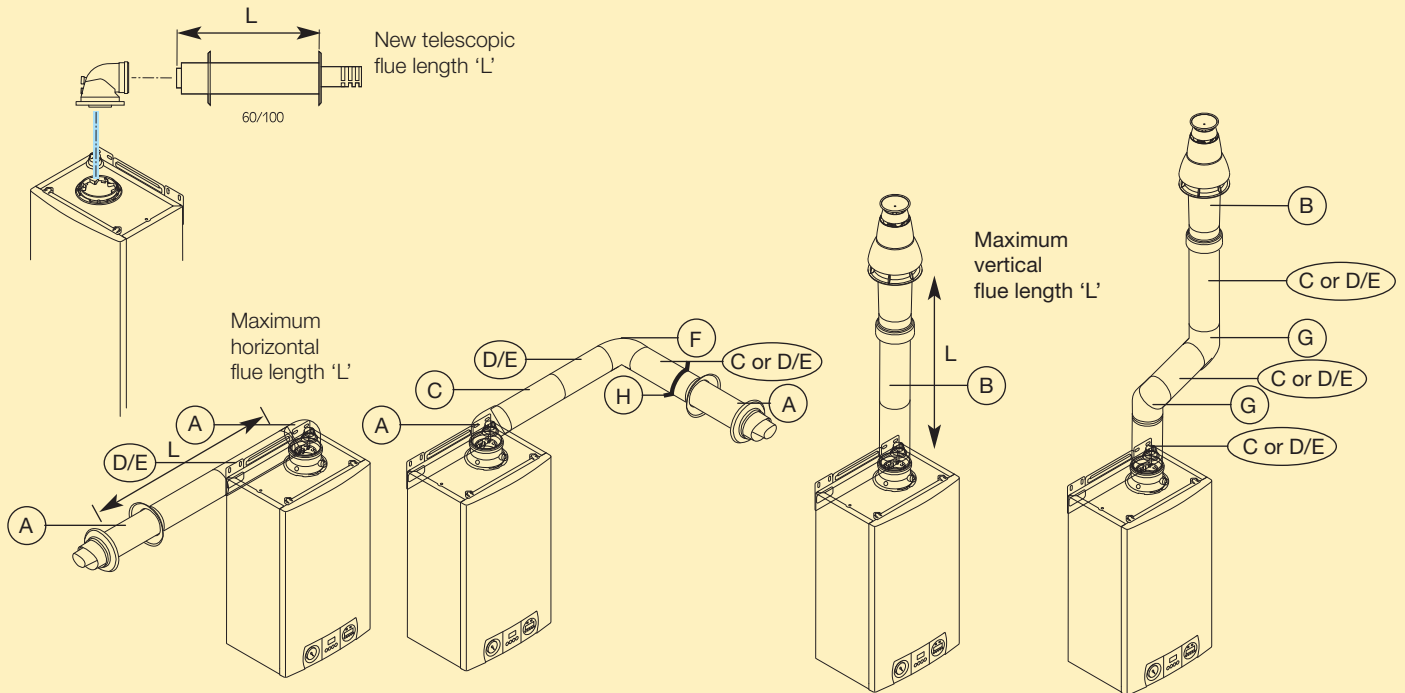

NOTE: The 90° Bend supplied with the horizontal flue kit is not included in any equivalent length calculations.

Boiler Type	12v / 15v / 18v / 24v / 30v	18s / 24s / 30s	24c / 28c / 35c / 39c / 28Eco
Telescopic flue length 'L' (mm)	* See to the right	250 - 450mm	250 - 450mm

\* This can be used with the original bend – please contact Remeha technical department for further information.  
NOTE: Telescopic Flue System - 450mm for Standard Flue.  
1000mm Flue Option also available. 60/100 Extended Telescopic Flue.

Boiler Type	12v / 15v	18v / 24v	30v	18s	24s	30s	24c	28c / 28Eco	35c	39c
Flue diameter (mm)	80/125 60/100	80/125 60/100	80/125 60/100	80/125 60/100	80/125 60/100	80/125 60/100	80/125 60/100	80/125 60/100	80/125 60/100	80/125 60/100
Max vertical/horizontal flue length 'L' (m)	34 8	34 8	34 8	29 6	29 6	29 6	29 6	29 6	30 7	25 5

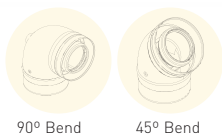

NOTE: For flue calculations and advice for multi-storey flats with a single rise please contact the Remeha support department.

For each 90° bend deduct 1.4m from the maximum flue length.  
For each 45° bend deduct 0.65m from the maximum flue length.

NOTE: For flue lengths in excess of details in above table larger flue systems are available – please contact Remeha for further details.

Position No	Description	Diameter	Length / Angle
A	Horizontal Concentric Flue Kit	60/100 mm	600 mm
B	Vertical Concentric Flue Kit	60/100 mm	600 mm
C	Cuttable Concentric Flue Extension	60/100 mm	500 mm
D	Non Cuttable Concentric Flue Extension	60/100 mm	500 mm
E	Non Cuttable Concentric Flue Extension	60/100 mm	1000 mm
F	Concentric Flue Bend	60/100 mm	90°
G	Concentric Flue Bend	60/100 mm	45°
H	Wall Bracket	60/100 mm	N/A
I	Pitched roof weather slate for 60/100 mm Flue	100 mm	Flexible
J	Flat roof weather slate for 60/100 mm Flue	100 mm	400x600 Sq

See our flue booklet for the full range of flue accessories and components.

# Minimum distances to terminal (clearance)

**1 Plume Management**  
PM Horizontal terminal kit installed with 1m extension

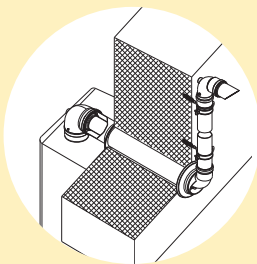

**2 Plume Management**  
PM Horizontal terminal kit with a vertical outlet

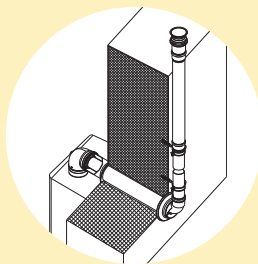

**3 Balcony Terminal**  
PM Horizontal balcony kit suitable for a 2m balcony or overhang

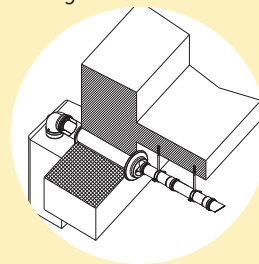

**4 Plume Management**  
PM Horizontal terminal kit installed with an adjustable deflector outlet

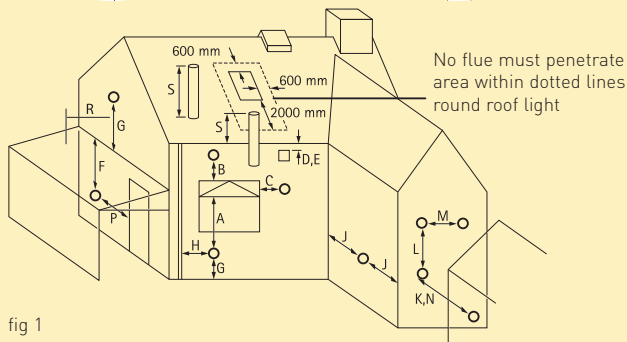
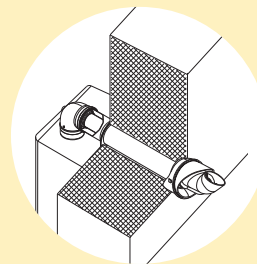

fig 1

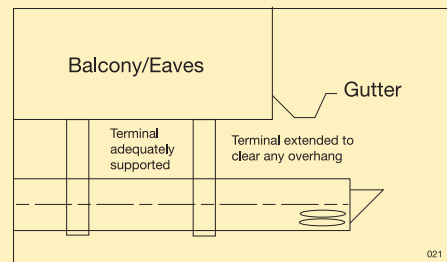

fig 2

Dimensions	Terminal Location	Min Distance (in mm) to Terminal (room sealed)
A	Directly below an opening, air brick, opening window, etc.	300
B	Above an opening, air brick, opening window, etc	300
C	Horizontally to an opening, air brick, opening window, etc.	300
D	Below a gutter or sanitary pipe work	75
E	Below the eaves	200
F	Below a balcony or carport roof	200
G	Above ground, roof or balcony level	300
H	From vertical drain / soil pipe work	40
J	From an internal or external corner	300
K	From a surface or boundary facing the terminal	600
L	Vertically from a terminal on same wall	1500
M	Horizontally from a terminal on same wall	300
N	From a terminal facing the terminal	1200
P	From an opening in a carport (e.g. door, window) into the building	1200
R	From a vertical structure	500#
S	Above an intersection with the roof	300

# This dimension to be increased to 1500mm if combustible material

**Note (fig 1):** Dimensions D, E and F can be reduced to 40mm without affecting boiler performance but we would advise deflectors for these small distances and also to ensure that the condense plume does not affect adjacent surfaces. Also in addition to dimension E the terminal can be extended as shown in the diagram (fig 2) to the maximum lengths on page 12.

**Note (fig 2):** It is important when fitting a plume management and balcony kit that the dimensions in table must be maintained in relation to both the air inlet as well as the flue outlet.

## The Telescopic Flue System for even more flexibility

The most compact boiler on the market now comes with the most versatile flue system, which gives an extra 100mm clearance above the boiler.







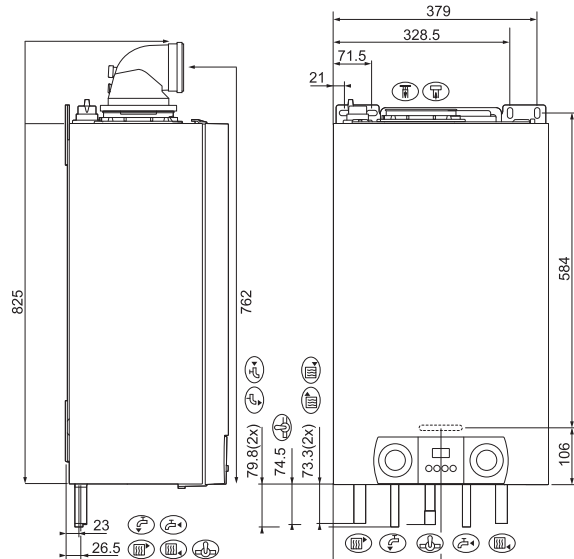
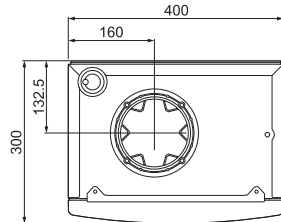

# Space saving dimensions

## Avanta Combination Boiler Avanta System Boiler



### Dimensions & connection points

-  Central heating return, dia. 22 mm
-  Central heating flow, dia. 22 mm
-  Gas connection dia. 22 mm
-  Concentric flue/air inlet dia. 60/100 mm
-  DHW cold, dia. 15 mm (combi only)
-  DHW hot, dia. 15 mm (combi only)
-  Condensate drain dia. 3/4" (overflow)



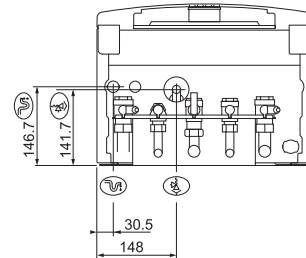

Note: Isolation valves/connections are within the casing height.  
Recommended installation clearance only 250mm top and bottom.

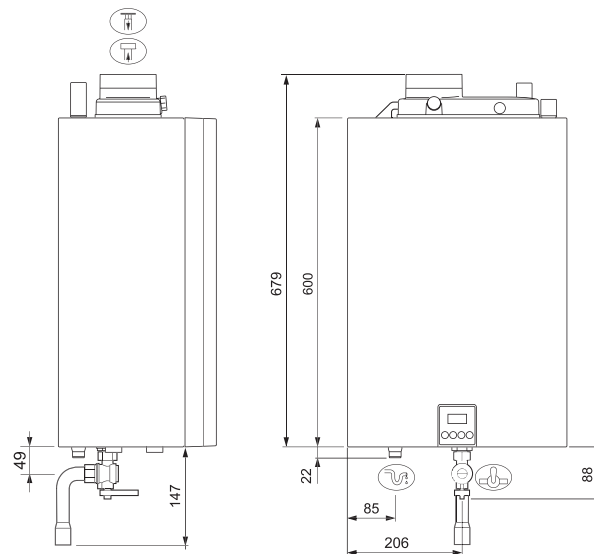
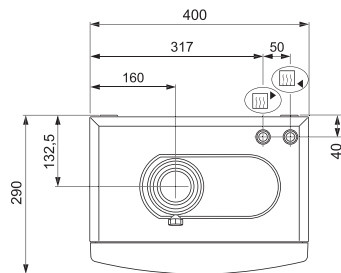

## Avanta Heating Boiler



### Dimensions & connection points

-  Return connection dia. 22 mm
-  Flow connection dia. 22 mm
-  Gas connection dia. 22 mm
-  Concentric flue/air inlet dia. 60/100mm
-  Condensate drain connection 3/4" (standard overflow pipe size)

Note: Recommended installation clearance only 250mm top and bottom.

